

Article number: 604145040040

Description: Timing belt pulley with hub
HTD 40 14M 40

Measures

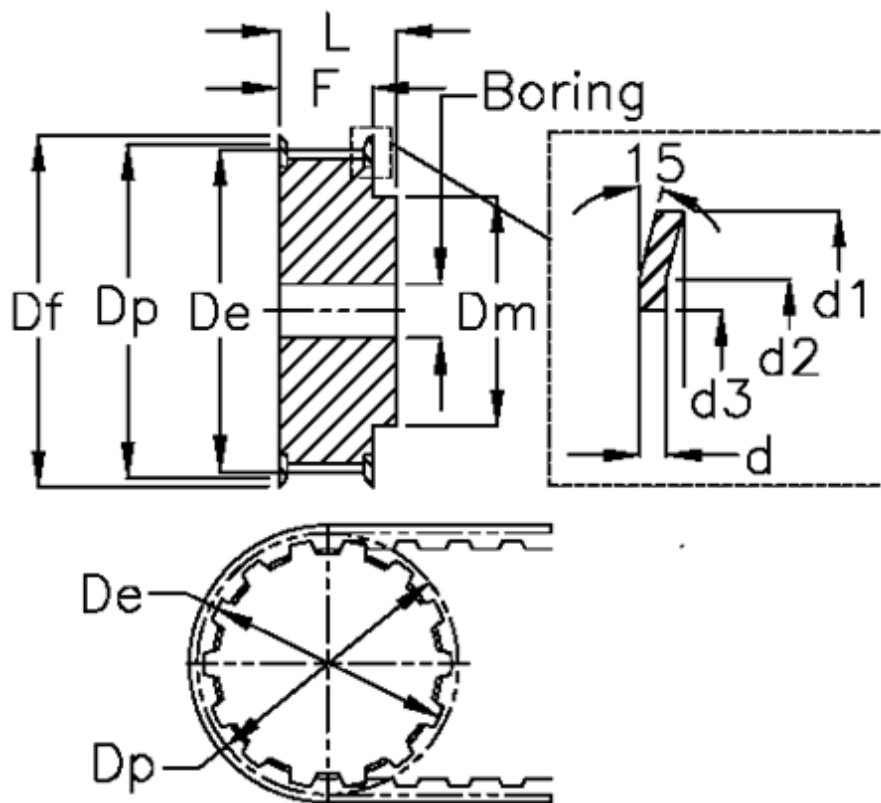

Bore = 24	Dp	= 178.25
d = 2.5	F	= 54
d1 = 188	Flange type	= F56
d2 = 176	L	= 69
d3 = 150	Tooth number	= 40
De = 175.49	Type	= 14M
Df = 188	Weight	= 9.26
Dm = 120	Width	= 40